

No. 26040502C  
MERCEDSES BENZ

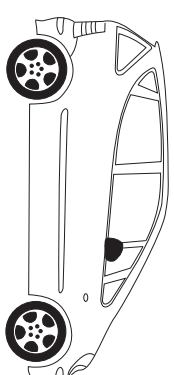

W168 A-Klasse 10/97 →

ConWys AG

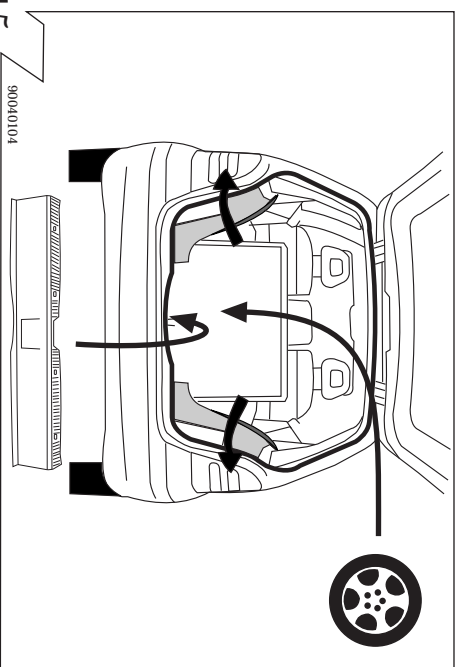

15

90040104

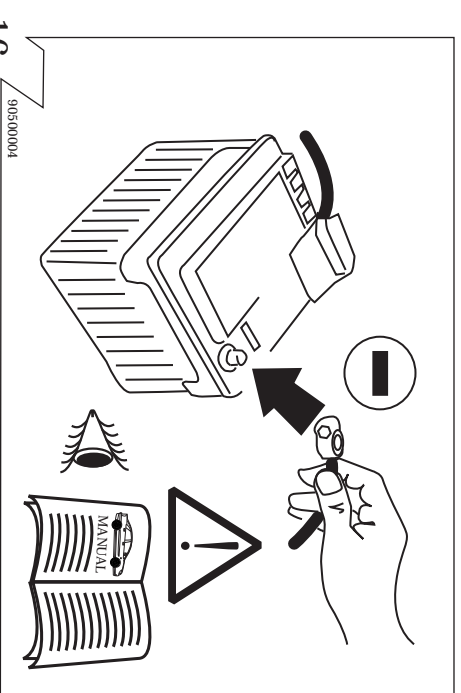

16

90500004

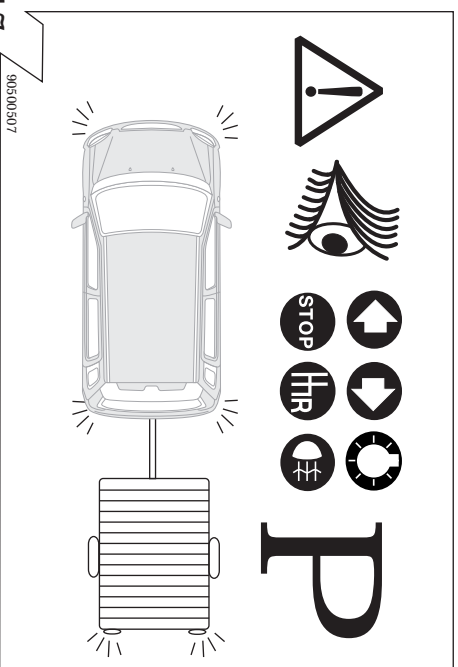

17

90500507

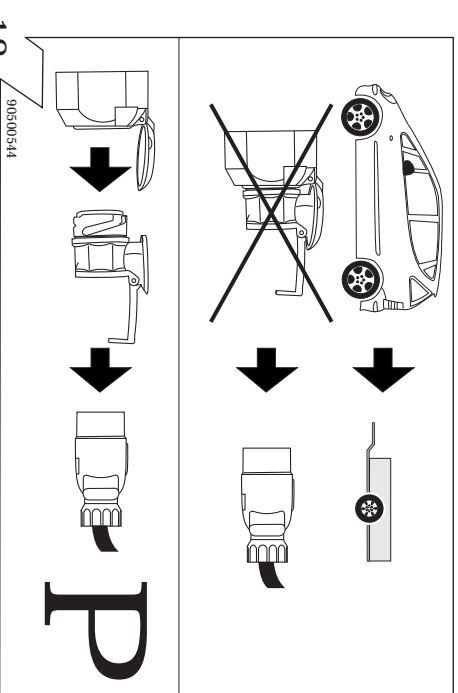

18

90500544

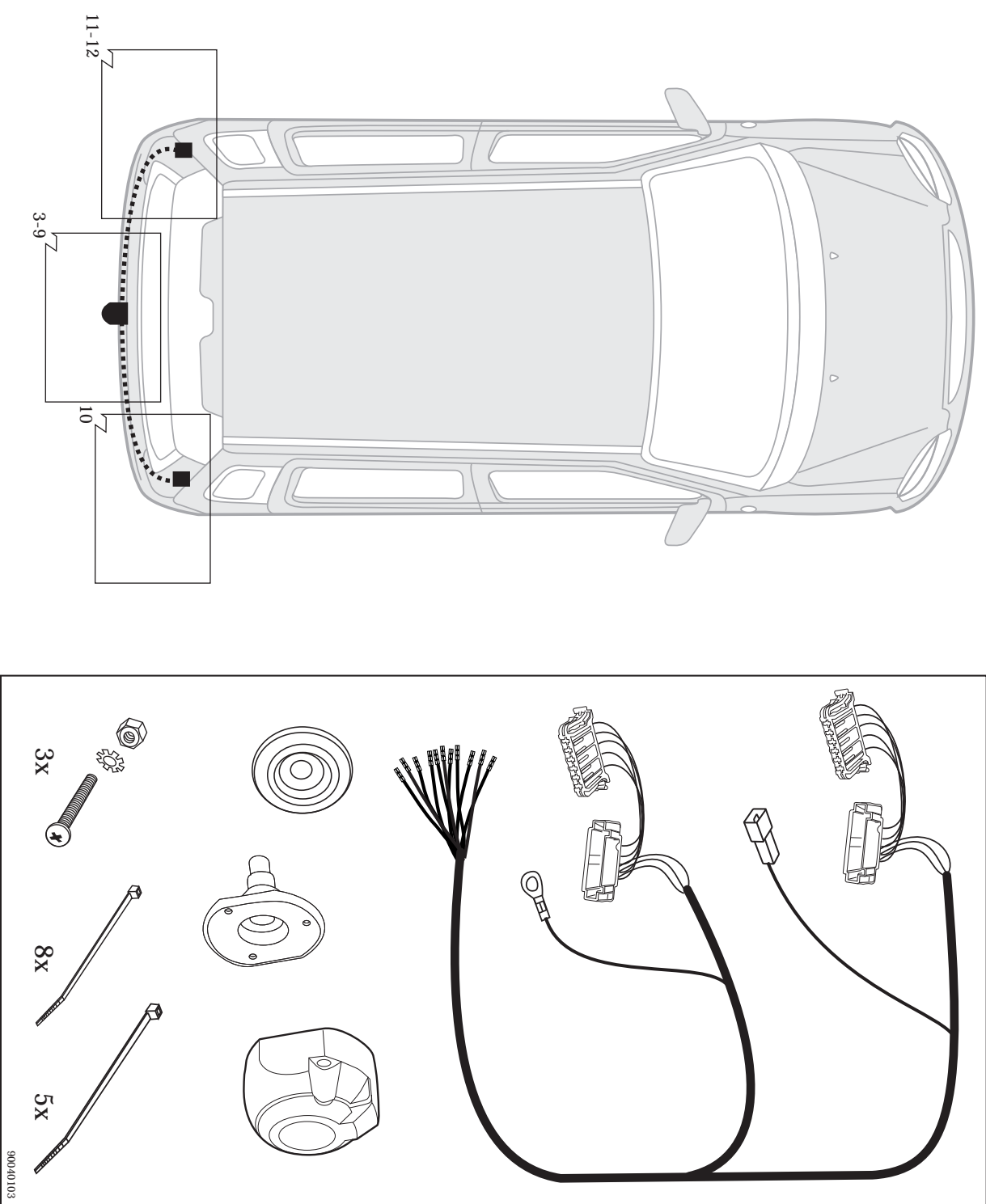

⚠ Vor Beginn der Arbeiten unbedingt die Einbauanleitung komplett durchlesen. Nach Einbau des Elektrosatzes ist die Einbauanleitung den Urhebern des Fahrzeuges beizulegen. Der Einbau des Elektrosatzes muß von einer Fachwerkstatt oder einer entsprechend qualifizierten Person durchgeführt werden. Bei unsachgemäßer Anwendung oder Veränderung des Elektrosatzes bzw. der darin befindlichen Bauteile erhöht jeder Anspruch auf Gewährleistung. Elektronische Bauteile sind vom Umrisch angeschlossen. Beim Fahrten ohne Anhänger oder Ladung sind die Lichter, die sich bei Stechdose einleuchten, werden. Änderungen bezüglich Konstruktion, Ausfertigung, Farbe sowie Form werden, übernehmen wir keine Verantwortung und Gewährleistung.

⚠ Before starting work, you must read the installation instructions through completely. After installing the towing electric kit, the installation instructions should be kept with the vehicle documentation. Installation of the towing electric kit must be undertaken by a specialist workshop or an appropriately qualified person. All claims under the guarantee will lapse in case of improper use or modification of the towing electric kit or any components contained within it. Electronic components can not be exchanged. When driving without a trailer or charge carrier, any adapter installed must be removed from the electrical socket. We reserve the right to alter the design, equipment, colour and any errors. All details and illustrations are nonbinding. We accept no responsibility and give no guarantee for technical and electronic alterations made after the initial operation of the electronic component.

⚠ Avant le début des travaux, lire impérativement les instructions de montage dans leur intégralité. Après le montage du kit électrique, joindre les instructions de montage aux documents du véhicule. Le montage du kit électrique doit être effectué par un atelier spécialisé ou par une personne qualifiée en la matière. Un usage inapproprié ou des modifications du kit électrique, ou des pièces qui le composent, entraînent l'expiration de tout droit à la garantie. Les composants électroniques ne sont ni repris ni échangés. Lors d'une conduite sans remorque ou porteur de charge, les adaptateurs utilisés doivent, le cas échéant, toujours être enlevés de la prise de courant. Sous réserve de modifications de construction, équipement, couleurs ou erreur. Données et illustrations sous toute réserve. Nous n'assumons aucune responsabilité ni garantie pour les modifications techniques et électroniques ayant été effectuées après la première mise en service du groupe électrique.

⚠ Prima di iniziare i lavori leggere attentamente le istruzioni di montaggio. Dopo aver installato il kit elettrico si prega di allegare queste istruzioni ai documenti dell'autoveicolo. L'installazione del kit elettrico deve essere effettuata esclusivamente da un officina o da personale specializzato. La garanzia non copre le parti che risultano difettose a causa di modifiche al kit elettrico o a componenti del medesimo. La garanzia non copre i danni risultanti da un uso inappropriato del kit elettrico. Le componenti elettroniche non possono essere sostituite. Durante la guida senza rimorchio o portacarichi, togliere gli adattatori utilizzati dalla presa di corrente. Con riserva di modifiche relative a costruzione, equipaggiamento, colore nonché salvo errori. Indicazioni e illustrazioni non sono vincolanti. Per le modifiche tecniche ed elettroniche che vengono eseguite dopo la prima messa in esercizio del kit elettrico non assumiamo alcuna responsabilità e garanzia.

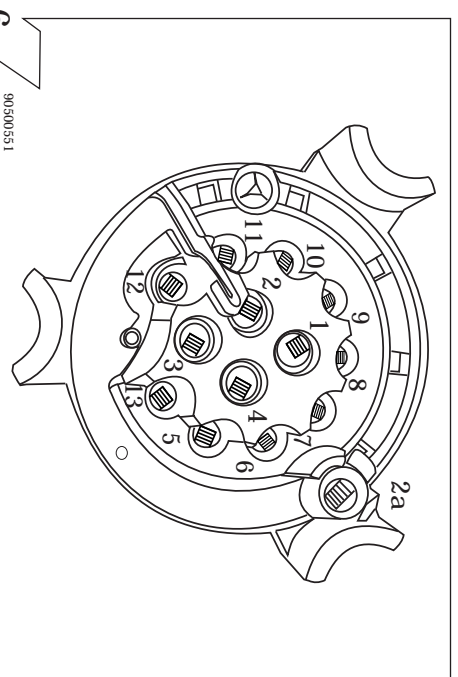
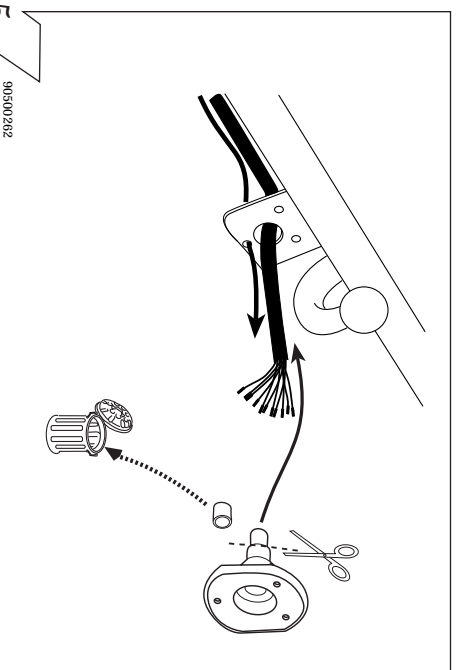
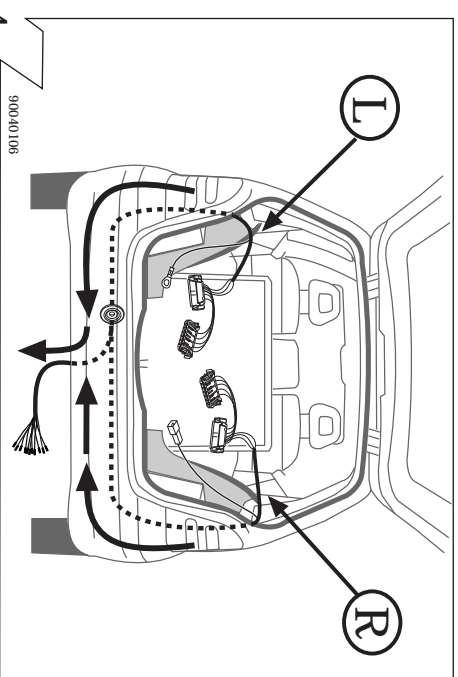
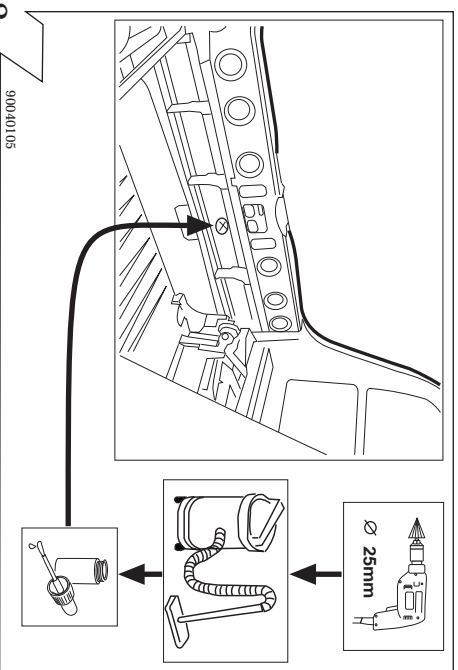
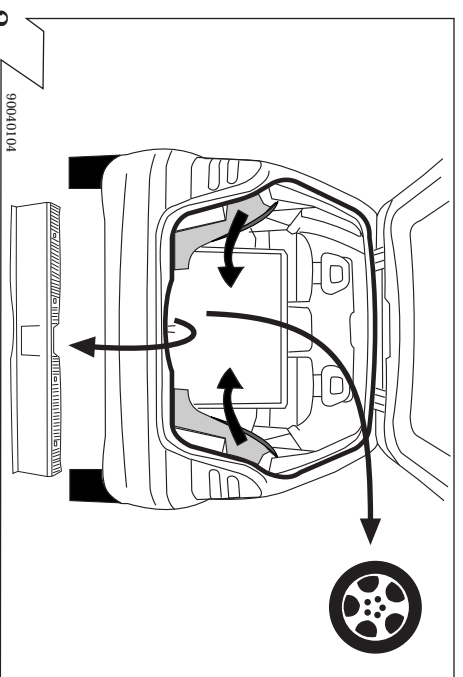
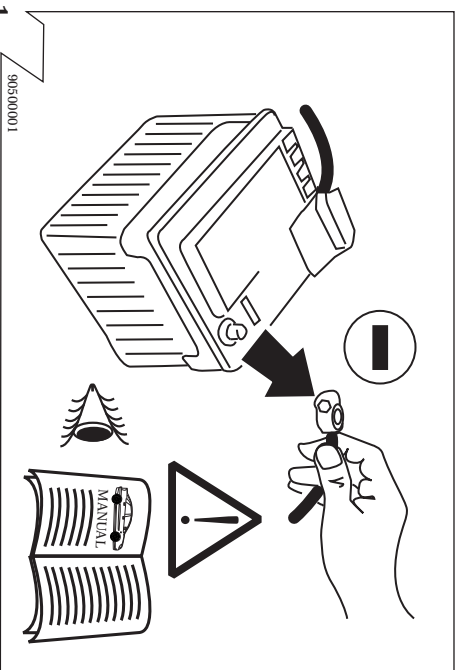

ISO 11446

Regolung der Steckdose/Socket Configuration  
Correspondance des Contacts de la prise  
Cavi della presa elettrica sono abbinati

↔	1/L	BK/WT
↔	2	WT
↔	2a	BK
↔ 1-8	3/31	BR
↔	4/R	BK/GN
↔	5/58-R	GY/RD
↔	6/54	BK/RD
↔	7/58-L	GY/BK
Reverse	8	BL/RD
↔ 20 amp	9	RD
↔ 15 amp	10	×
↔ 10	11	×
↔	12	×
↔ 9	13	RD/BR

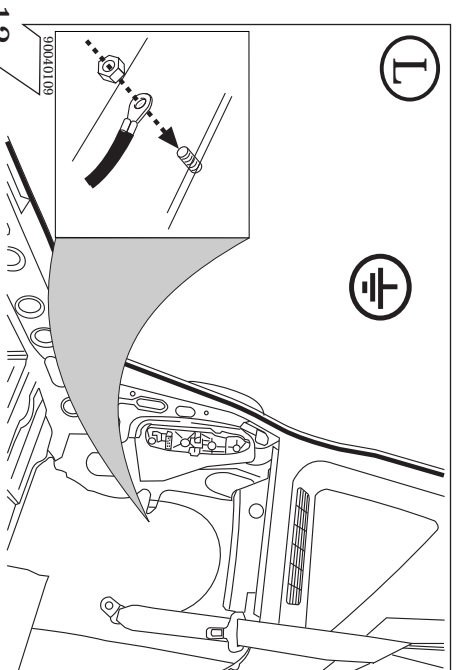
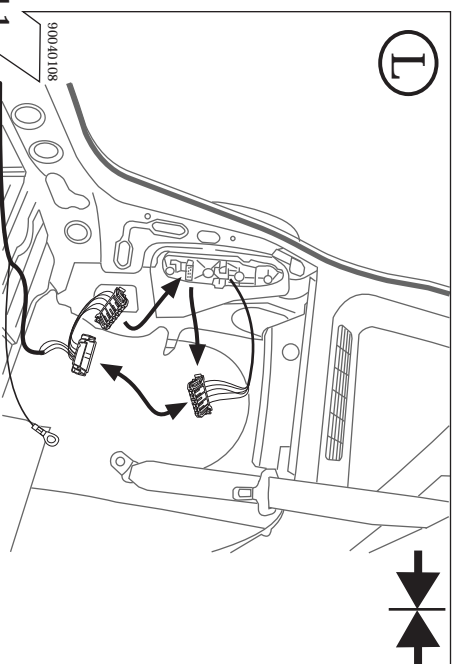
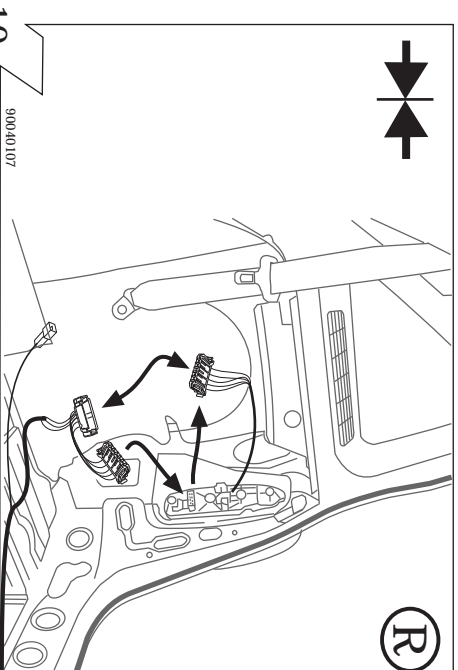
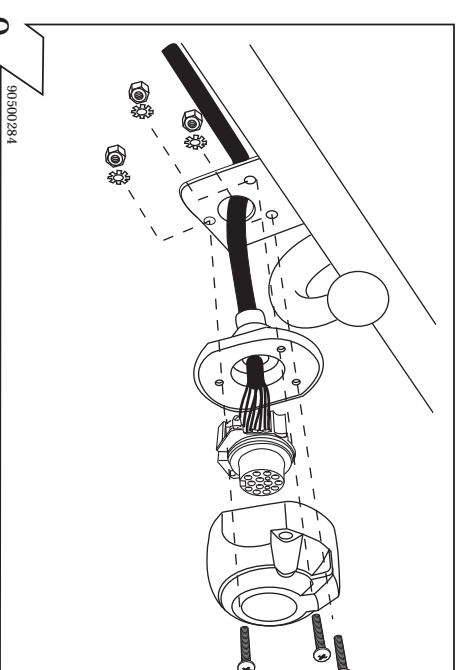

90500580

	(GB)	(D)	(E)	(F)	(I)	(P)	(NL)	(DK)	(N)	(S)	(FIN)	(CZ)	(H)	(PL)
BK	Black	Schwarz	Negro	Noir	Nero	Preto	Zwart	Sort	Svart	Svart	Musta	Černá	Fekete	Czarny
RD	Red	Rot	Rojo	Rouge	Rosso	Vermelho	Rood	Rød	Rød	Röd	Punainen	Červená	Piros	Czerwony
GN	Green	Grün	Verde	Vert	Verde	Verde	Green	Grøn	Grøn	Grøn	Vihreä	Zelená	Zöld	Zielony
OR	Orange	Orange	Naranja	Orange	Anarance	Laranja	Orange	Orange	Orange	Orange	Oranssi	Oranžová	Narancs	Pomarańczowy
VT	Violet	Violet	Violeta	Violet	Viola	Violeta	Violet	Fiolet	Violet	Violet	Violeti	Fialová	Bjolya	Fioletowy
PK	Pink	Pink	Pink	Rose	Rosa	Cor-de-Rosa	Pans	Pink	Pink	Rosa	Pinkki	Růžová	Rózsaszín	Różowy
BL	Blue	Biau	Azul	Bleu	Blu	Azul	Blauw	Bla	Bla	Bla	Sininen	Modrá	Kék	Niebieski
YL	Yellow	Gelb	Amarillo	Jaune	Giallo	Amarillo	Geel	Gul	Gult	Gul	Keltainen	Žlutá	Szaga	Żółty
WT	White	Weiss	Blanco	Blanc	Bianco	Branco	Wit	Hvid	Hvitt	Vit	Valkoinen	Bílá	Fehér	Biały
BR	Brown	Braun	Marón	Brun	Marrone	Marrom	Bruin	Brun	Brun	Brun	Ruskka	Hnědá	Barna	Brazowy
GY	Grey	Grau	Gris	Gris	Grigio	Chizenio	Grijs	Griá	Graitt	Griá	Hammaa	Sedá	Szauke	Szary

