



RENAULT
MEGANE GRAND SCENIC III

04/2009 -

Cat. No. **R/050**

E20

E20 55R-01 3763

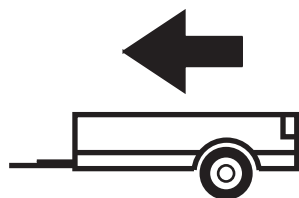

1400kg

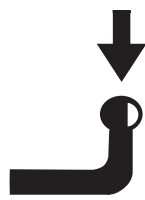

75kg

D=8,24kN

$$D \text{ (kN)} = \frac{\text{MAX kg} \times \text{MAX kg}}{\text{MAX kg} + \text{MAX kg}} \times 0,00981$$

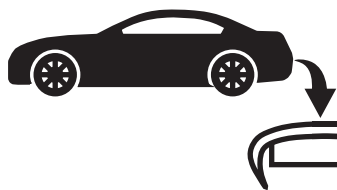

IMIOLA HAK-POL

96-111 KOWIESY, CHOJNATA 23A, POLAND

Tel. + 48 46 831 73 31, fax +48 831 74 29

e-mail: office@imiola.pl, www.imiola.pl

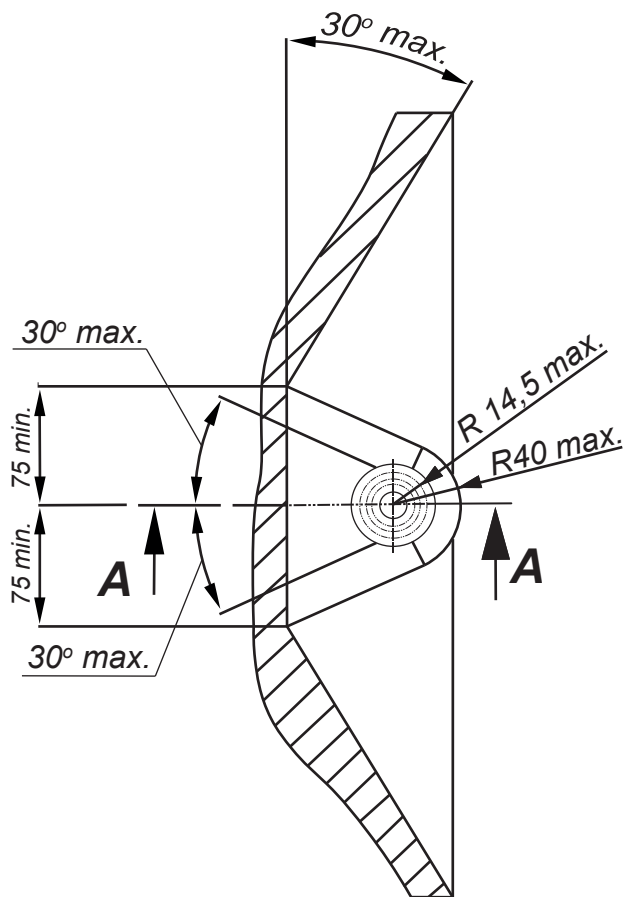

PRZEKRÓJ A-A

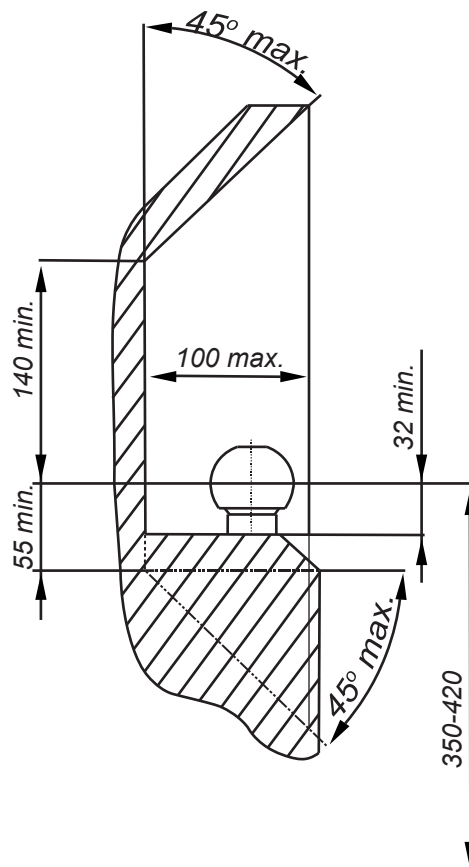

PL Należy zagwarantować przestrzeń swobodną według załącznika VII, rysunek 25a/b Regulaminu EKG ONZ 55.01 przy dopuszczalnym ciężarze całkowitym pojazdu.

F L'espace libre doit être garanti conformément à l'annexe VII, illustration de la réglementation 55.01 CE pour un poids total en charge autorisé du véhicule.

GB The clearance specified in appendix VII, diagram 25a/b of Regulation No. 55.01 UN EU must be guaranteed at laden weight of the vehicle.

D Der Freiraum nach Anhang VII, Abbildung 25a/b der Vorschriften 55.01 EG ist zu gewährleisten bei zulässigem Gesamtgewicht des Fahrzeuges.

Moment skręcający dla śrub i nakrętek (8.8) Torgue settings for nuts and bolts (8.8)	
M8	25Nm
M10	55Nm
M12	85Nm
M14	135Nm
M16	195Nm

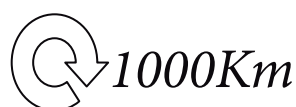

Śruba M10x35-8.8 ; Bolt
Podkl. spręż. 10,2 ; Spring Washer
Podkl. okr. Ø30x Ø10,5x 3 ; Plain Washer

Śruba M12x45-8.8 ; Bolt
Podkl. spręż. 12,2 ; Spring Washer
Podkl. okr. 13 ; Plain Washer

Śruba M10x45-8.8 ; Bolt
Podkl. spręż. 10,2 ; Spring Washer
Podkl. okr. Ø30x Ø10,5x 3 ; Plain Washer

Śruba M12x45-8.8 ; Bolt

Nakrętka M12 ; Nut
Podkl. spręż. 12,2 ; Spring Washer
Podkl. okr. 13 ; Plain Washer











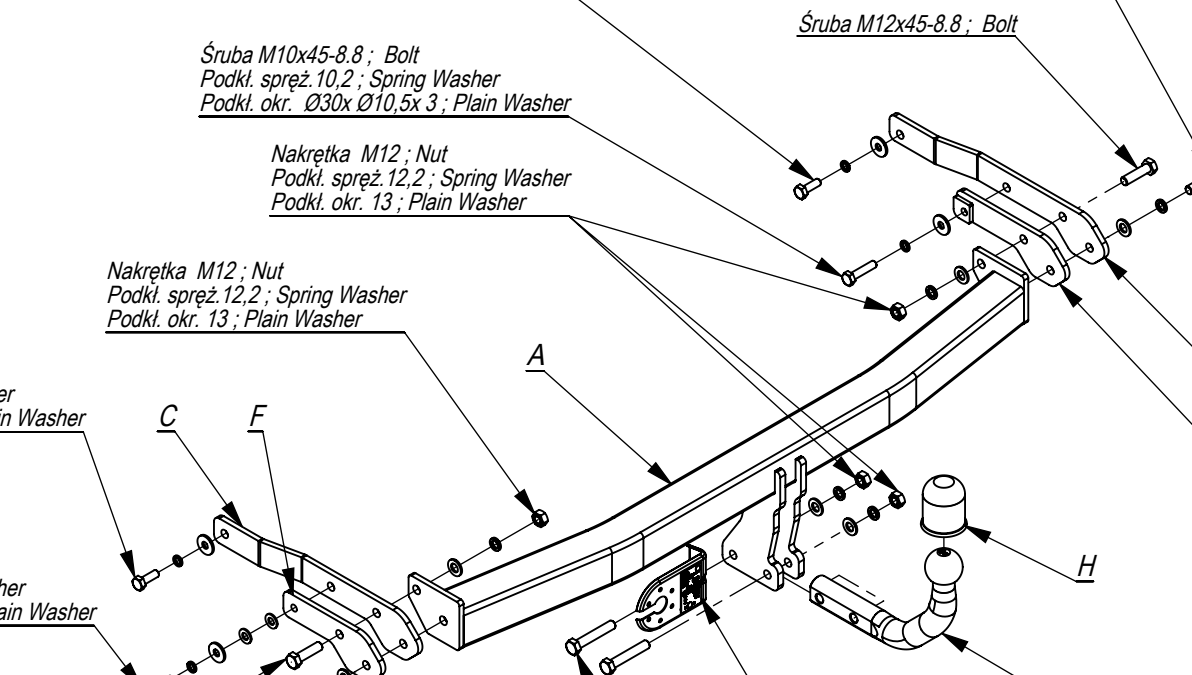
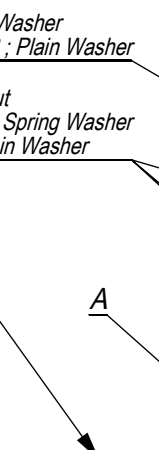

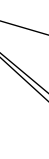
Nakrętka M12 ; Nut
Podkl. spręż. 12,2 ; Spring Washer
Podkl. okr. 13 ; Plain Washer

Śruba M10x35-8.8 ; Bolt
Podkl. spręż. 10,2 ; Spring Washer
Podkl. okr. Ø30x Ø10,5x 3 ; Plain Washer

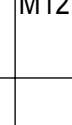
Śruba M10x45-8.8 ; Bolt
Podkl. spręż. 10,2 ; Spring Washer
Podkl. okr. Ø30x Ø10,5x 3 ; Plain Washer

Śruba M12x45-8.8 ; Bolt

Śruba M12x70-8.8 ; Bolt
Podkl. spręż. 12,2 ; Spring Washer
Podkl. okr. 13 ; Plain Washer

		A	x1		M12x70	2
					M12x45	4
					M10x45	2
					M10x35	2
		B	x1		M12	4
		C	x1		Ø30xØ10,5x3	4
		D	x1		13	6
		E	x1		12,2	6
		F	x1		10,2	4
		G	x1			
		H	x1			

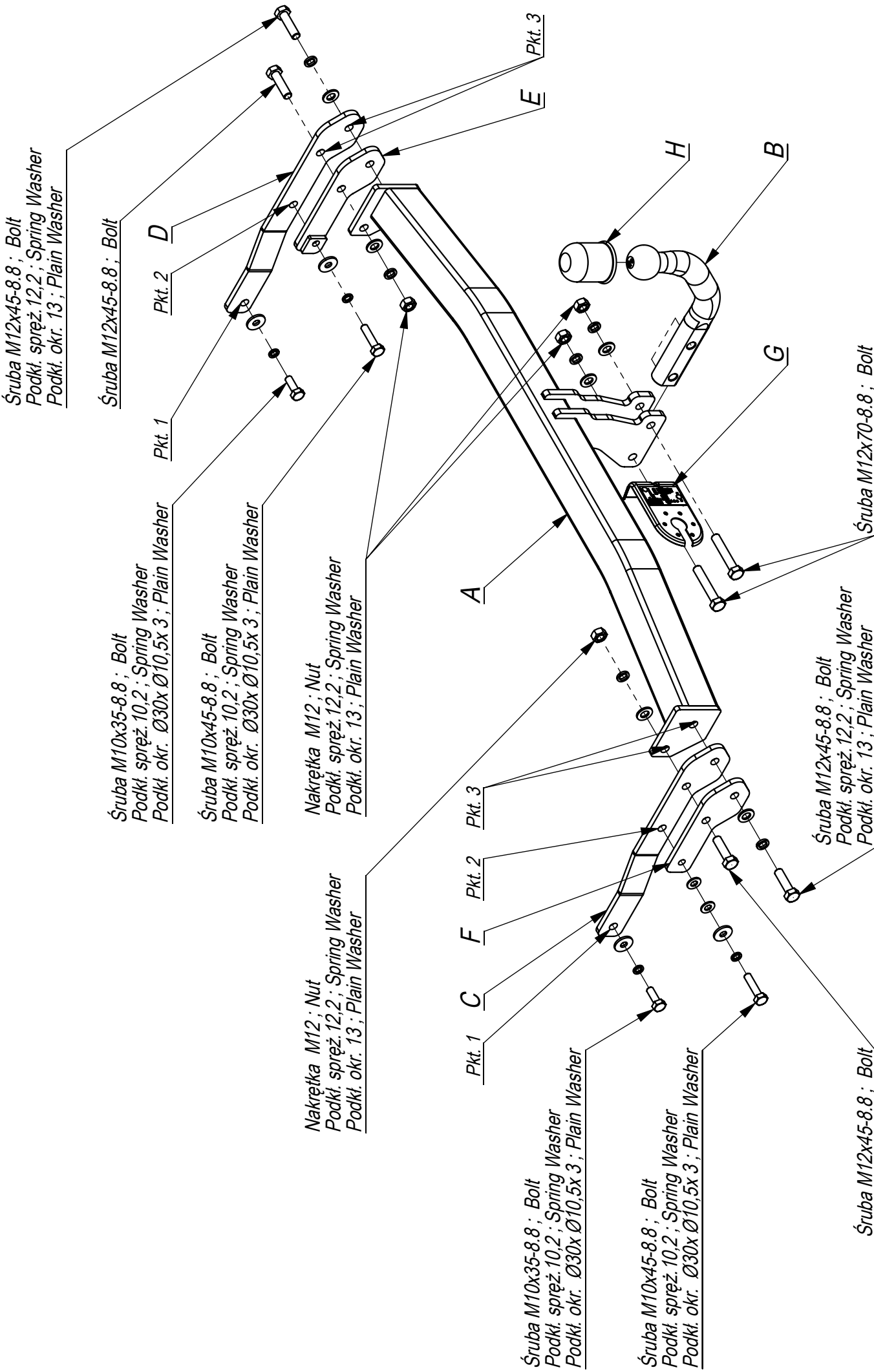

- x Odkręcić zderzak .
- x Odkręcić lampy i koła tylne.
- x Od tylnego pasa samochodu Odkręcić belkę zderzeniowa (nie będzie już wykorzystana).
- x Udrożnić otwory do podłużnic od strony tylnego pasa (wg rys.1).
- x W otwory podłużnic wsunąć elementy zaczepu C D i E F, poprzez technologiczne otwory w podłużnic skrócić lekko śrubami M10x45 8.8 (pkt 2) oraz M10x35 8.8 (pkt 1)
- x Miedzy elementy C i D wsunąć belkę zaczepu i skrócić lekko śrubami M12x45 8.8 (pkt 3).
- x Dokręcić wszystkie śruby z momentem wg tabeli.
- x Zamontować zderzak.
- x Przykręcić kule i blachę gniazda elektrycznego śrubami M12x70 8.8.
- x Podłączyć instalacje elektryczna.
- x Przykręcić tylne koła i lampy.

- x Disassemble the bumper.
- x Unscrew the rear lamps and rear wheels.
- x Unscrew the bumper bar from the rear belt of the car (it will not be used any more).
- x The holes in the metal clamps from the side of the rear belt make permeable (according to the drawing 1).
- x Insert elements C, D and E, F in the holes of the metal clamps, screw slightly through the technological holes in the metal clamps with bolts M10x45 8.8 (point 2) and M10x35 8.8 (point 1).
- x Insert the main bar between the elements C and D and screw slightly with bolts M12x45 8.8 (point 3).
- x Tighten all the bolts according to the torque setting -see the table.
- x Assemble the bumper.
- x Fix the ball and electric plate with bolts M12x70 8.8.
- x Connect the electric wires.
- x Screw the rear wheels and lamps.

- x Déposer le pare-chocs,
- x Dévisser les lampes et les roues postérieures.
- x Dévisser la poutre de chocs de la bande postérieure du véhicule (elle ne sera plus utilisée).
- x Déboucher les trous des longerons du côté de la bande postérieure (selon le dessin 1).
- x Introduire les éléments d'attache C,D et E,F et ensuite visser légèrement par les boulons M10x45 8.8 (point 2) à travers les ouvertures de longerons et M10x35 8.8 (point 1),
- x Mettre la poutre du crochet entre les éléments C et D et visser légèrement à l'aide des boulons M12x45 8.8 (point 3)
- x Serrer tous les boulons avec un couple de serrage selon tableau.
- x Monter le pare-chocs.
- x Visser le crochet d'attelage et socle de prise électrique par les boulons M12x70 8.8.,
- x Raccorder le circuit électrique.
- x Visser les roues postérieures et les lampes.

- x Die Stoßstange abschrauben.
- x Vom hinteren Karosseriestreifen den Stoßstangebalken abschrauben, wird nicht wieder benutzt.
- x Die Löcher an den Seiten der Metallklammern machen durchlässig
- x In die Längsträger Öffnungen die Tragteile C und D und E,F durch die vom Werk aus vorhandenen Öffnungen mit den Schrauben M10x35 8.8 (Punkt 1) und M10x45 8.8 (Punkt 2) locker verschrauben.
- x Den Querbalken A mit den Tragteilen C und D mit den Schrauben M12x45 8.8 (Punkt 3) verschrauben.
- x Alle Schrauben mit dem in der Tabelle angegebenen Drehmoment festziehen
- x Die Stoßstange anschrauben.
- x Die Kugel mit der Steckdosenhalterung mit den Schrauben M12x70 8.8 anschrauben.
- x Die Elektroinstallation anschließen.

- x Desmontar el parachoques.
- x Desenroscar la barra de choques de la banda trasera del coche (ya no se usará).
- x Los agujeros en los lados de las abrazaderas metálicas lo hacen permeable
- x Introducir los elementos del enganche C y D (E y F) en los oricios de los largueros y atornillar ligeramente, a través de los oricios tecnológicos en el larguero, por medio de tornillos M10x45 8.8 (p. 2). y M10x35 8.8 (p. 1)
- x Atornillar los elementos C y D con la viga del enganche A (p. 3), usando tornillos M12x45 8.8.
- x Apretar todos los tornillos con el par según la tabla anterior.
- x Instalar el parachoques.
- x Apretar la bola y la placa eléctrica con los tornillos M12x70 8.8.
- x Conectar la instalación eléctrica.

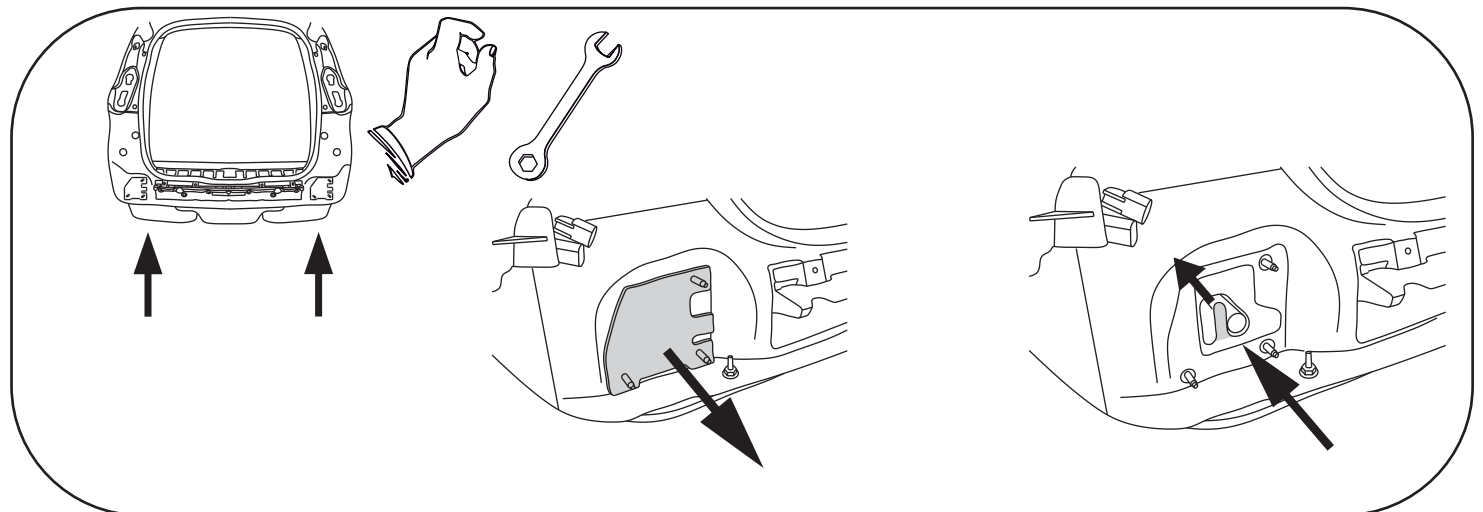
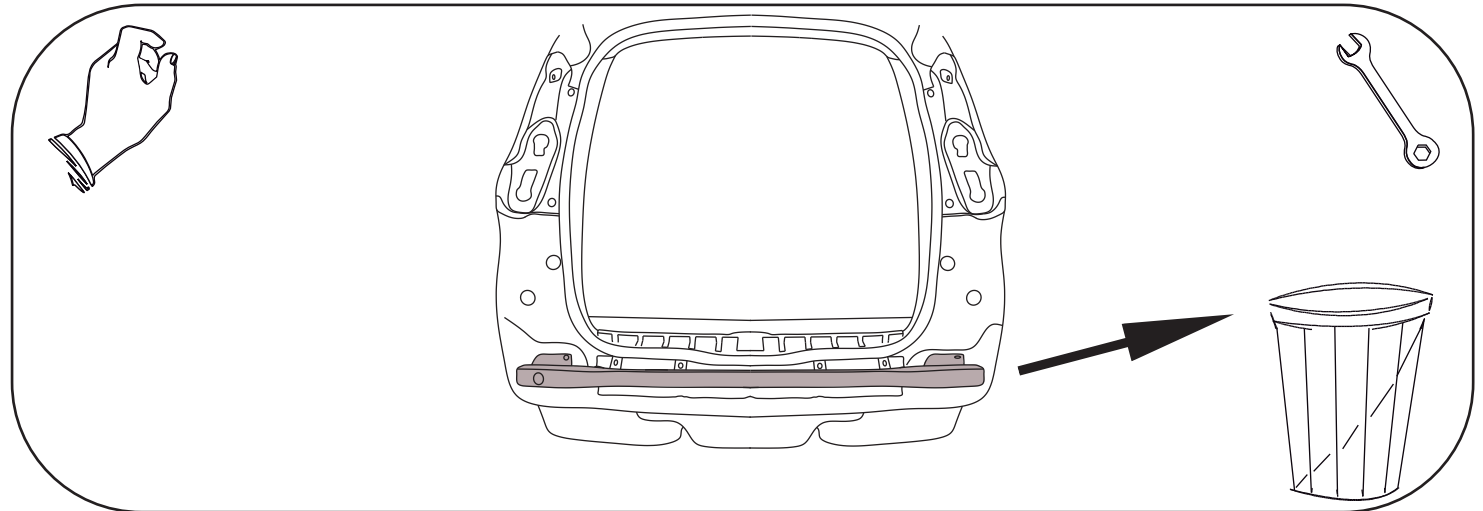
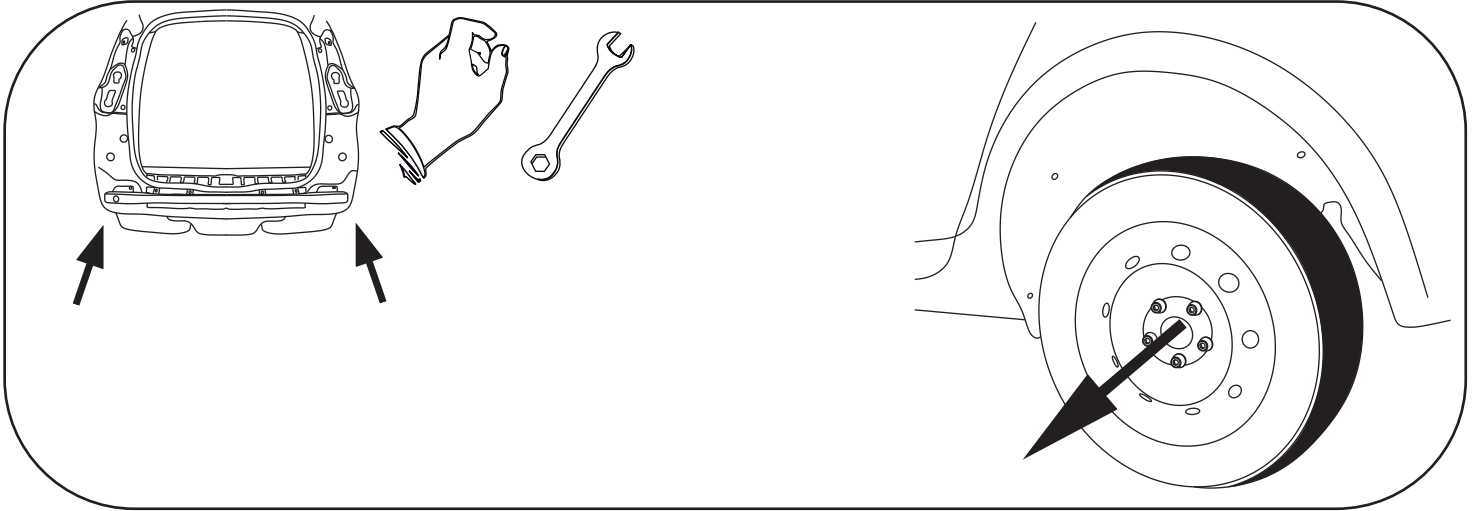
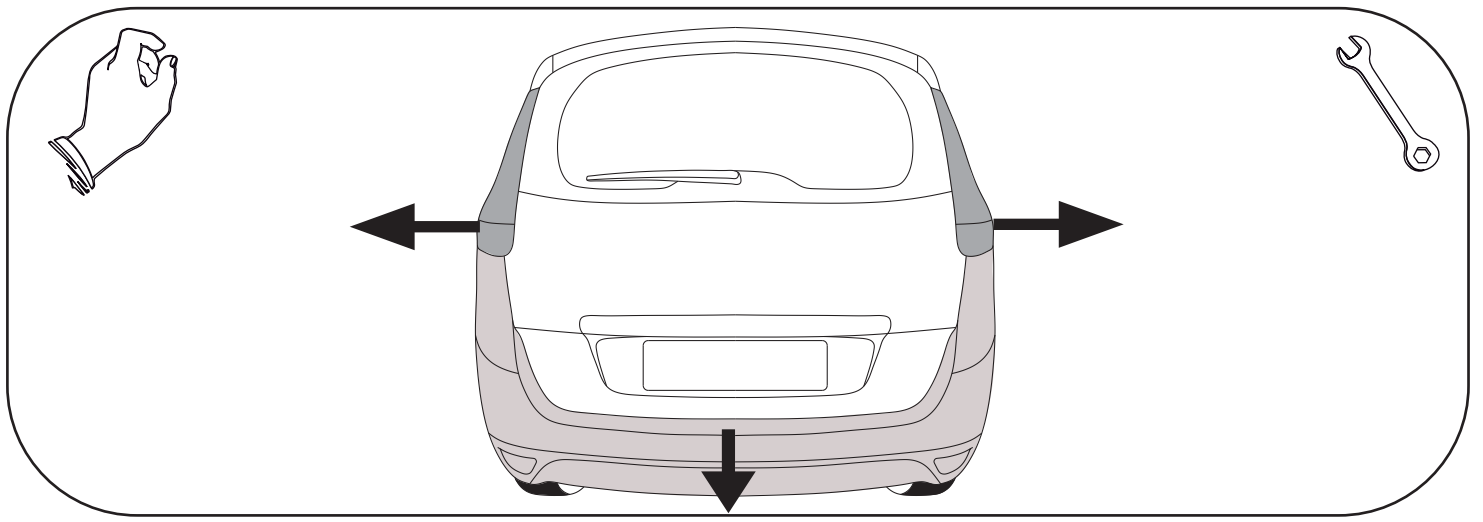

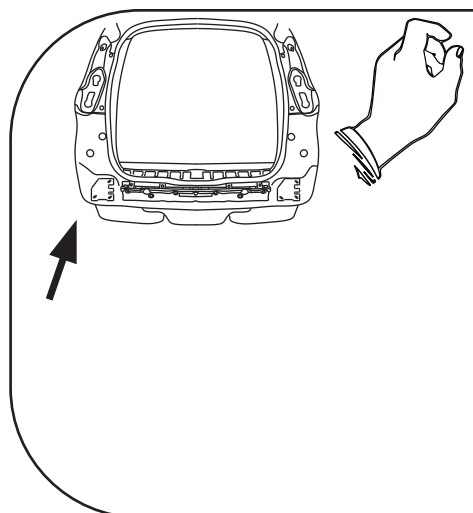
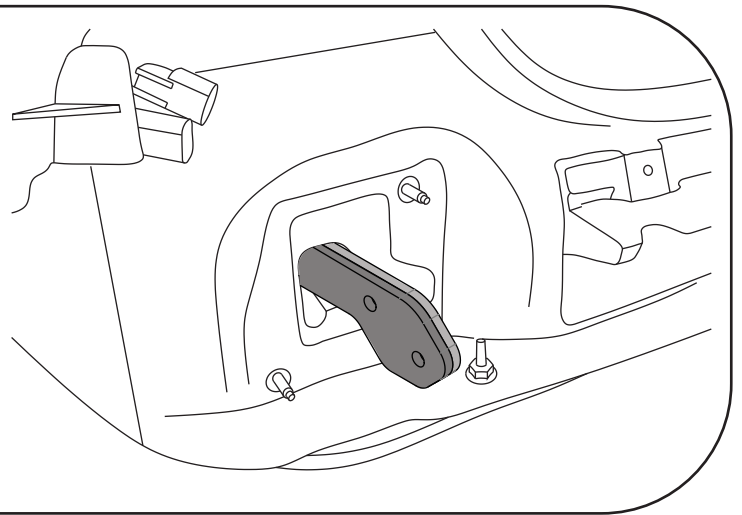
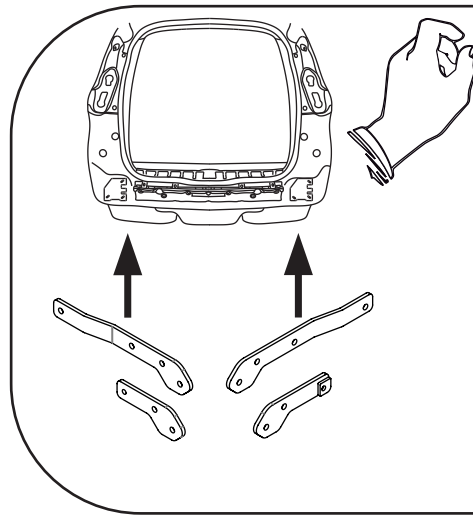
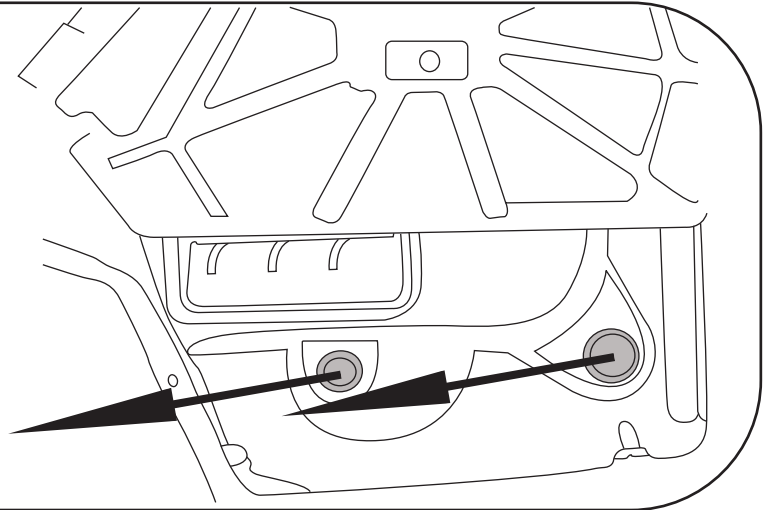
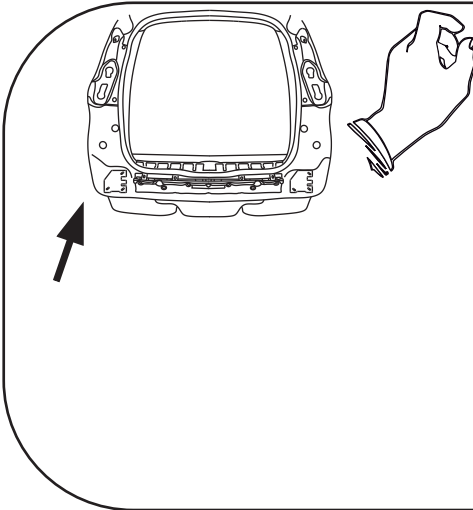
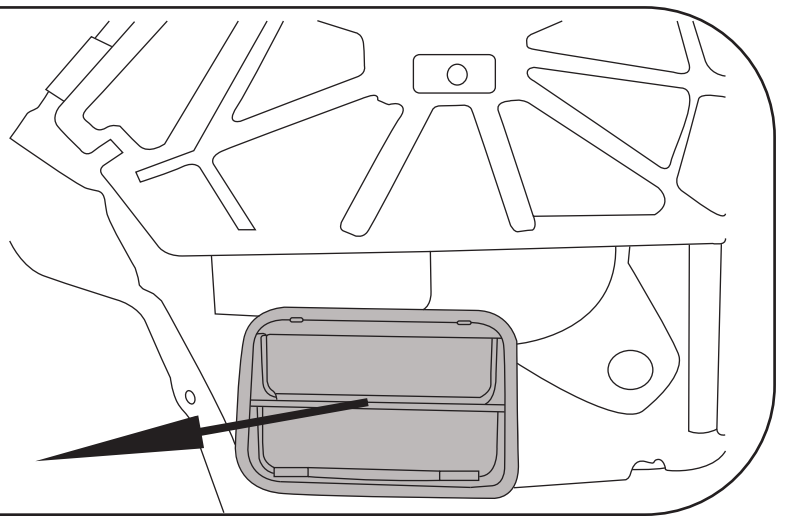
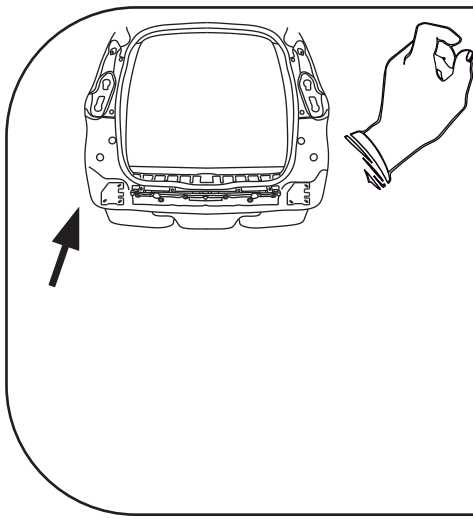

 M10x45 x1

 M10x35 x1

 10,2 x2

 Ø30xØ10,5x3 x2

